

Data Sheet



Article number: 201281314

Description: E+G Handwheel
GN 322-160-K14-R

Measures

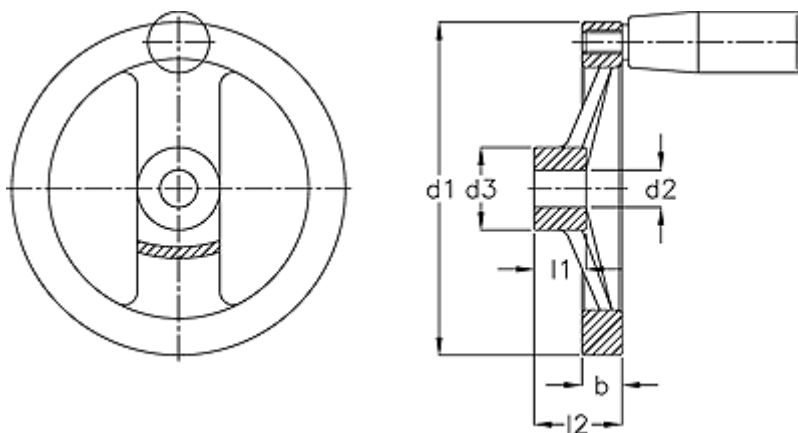

b	= 18.0
d1	= 160
d2 H7	= 14
d3	= 36
Handle	= 24
l1	= 20
l2	= 39